

COMUNELLO[®]

AUTOMATION

INSTALLATION AND USER'S MANUAL

CU - 230V - 2M

Control unit

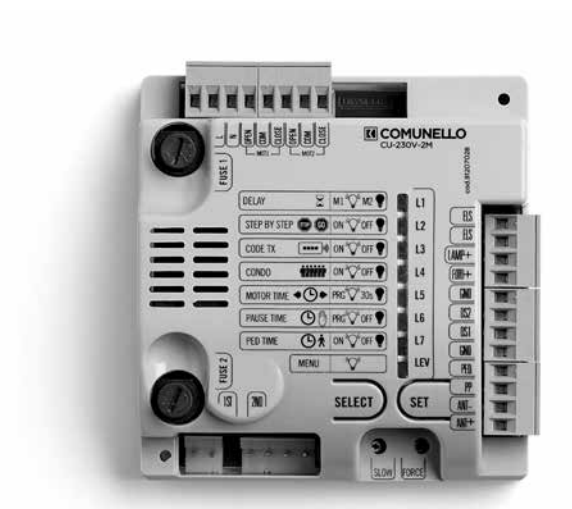



comunello.com

ISTRUZIONI D'USO E DI INSTALLAZIONE
INSTALLATIONS-UND GEBRAUCHSANLEITUNG
INSTRUCIONS D'UTILISATION ET D'INSTALLATION
INSTRUCCIONES DE USO Y DE INSTALACION
ИНСТРУКЦИЯ ПО МОНТАЖУ





Cod. 91300173 Rev. 01 - 25.03.15

MENÙ LIST
MAIN MENÙ

ID	LED	ON 	OFF 
L1	DELAY	Operator 1 delay	Operator 2 delay
L2	STEP BY STEP	Step-by-Step	Automatic
L3	CODE TX	Code entered	No code
L4	CONDO	ON	OFF
L5	MOTOR TIME	Programmed time	30 sec.
L6	PAUSE TIME	With automatic closing	Without automatic closing
L7	PED TIME	ON	OFF
LEV	MENÙ	ON	

EXTENDED MENÙ 1

ID	LED	ON 	OFF 
L1	PGM CODE	ON	OFF
L2	FOTOTEST	ON	OFF
L3	DECELERATION	OFF	ON
L4	LEAVES DELAY	ON	OFF
L5	RELEASE STROKE	ON	OFF
L6	SLAM LOCK	ON	OFF
L7	COURTESY LIGHT	ON	OFF
LEV	MENÙ	1 FLASH	

EXTENDED MENÙ 2



ID	LED	ON 	OFF 
L1	SOFT STOP	ON	OFF
L2	SOFT START	ON	OFF
L3	DS1 IN OPEN	ON	OFF
L4	HOLD-TO-RUN	ON	OFF
L5	FOLLOW ME	ON	OFF
L6	PAUSE FLASHING	ON	OFF
L7	ALWAYS CLOSE	ON	OFF
LEV	MENÙ	2 FLASHES	

FIG. 4



TABELLA CONNESSIONI CAVI AG01 - WIRES CONNECTION TABLE AG01

BASIC 230V – (CU 230V 2M)

ID	Description	Cable type	Lenght (1m to 20m)	Lenght (20m to 50m)
1	Main power supply	FG7 CEI 20-22 CEI EN 50267-2-1	3Gx1,5mm ²	3Gx2,5mm ²
6A	Motor power supply		4Gx1,5mm ²	4Gx2,5mm ²
2	Flashing light		2x0,5mm ²	2x1,0mm ²
4A , 5A	Photocell TX		2x0,5mm ²	2x1,0mm ²
4B , 5B	Photocell RX		4x0,5mm ²	4x1,0mm ²
7	Key selector		3x0,5mm ²	3x1,0mm ²
3	Antenna	RG58	max 20m	

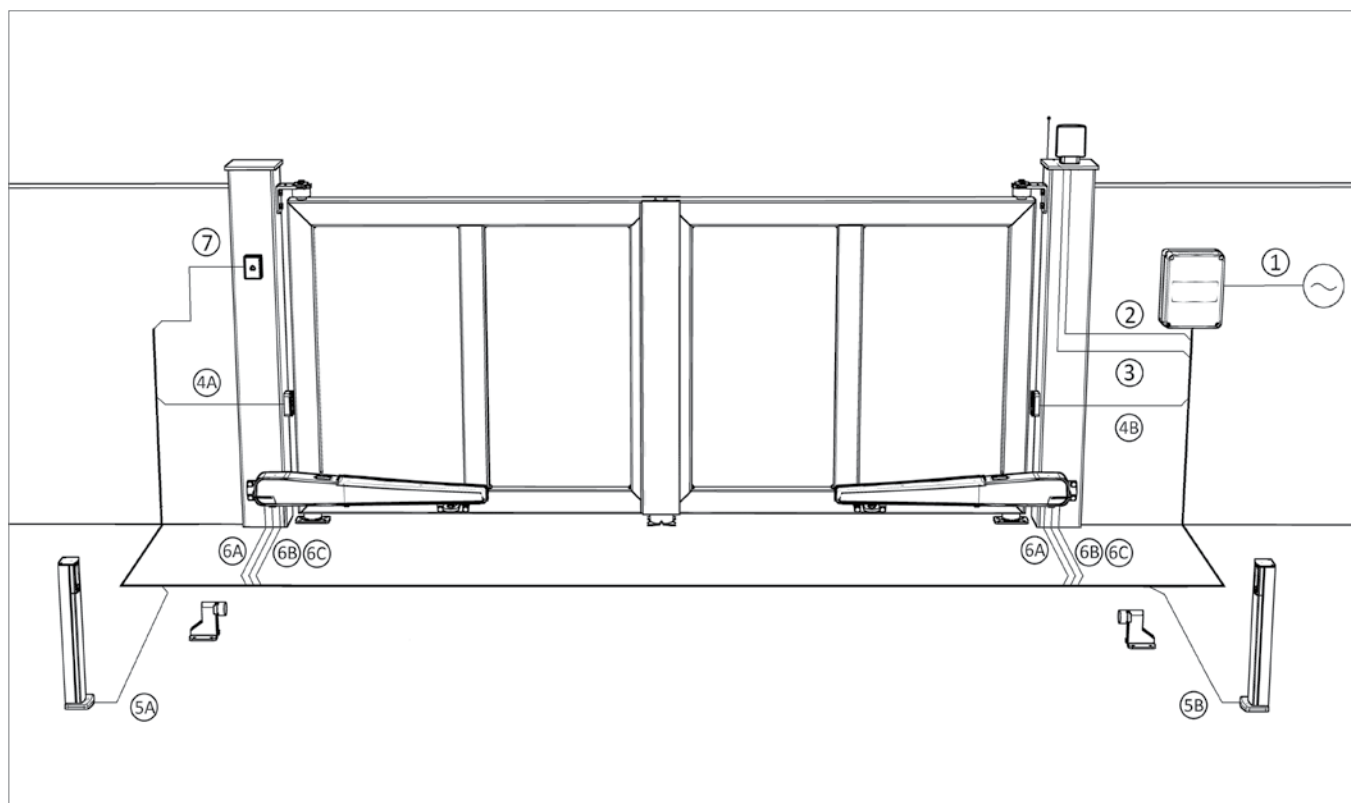
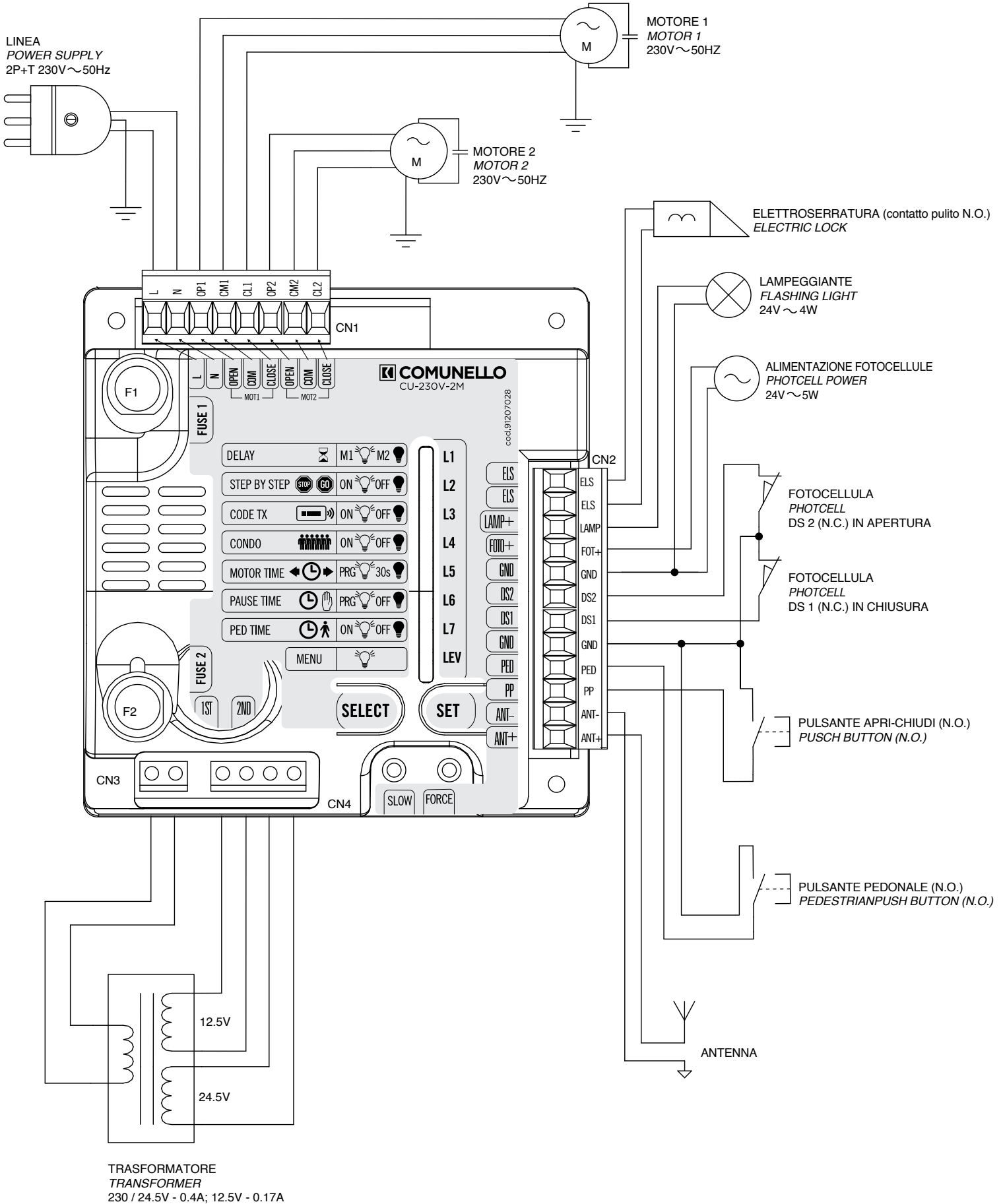

ABACUS - connection diagram of the motors

- DELAY LED OFF = DELAY OF THE MOTOR n.2

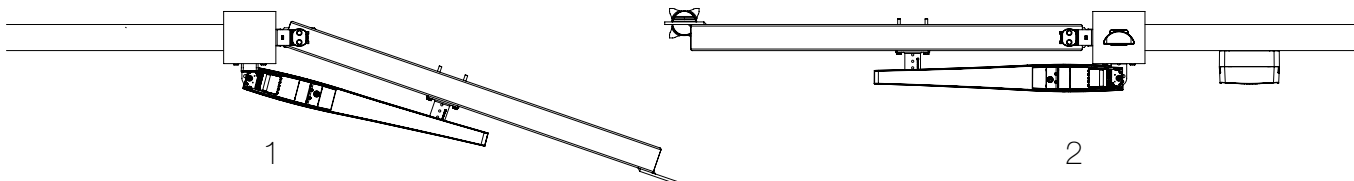

- DELAY LED ON = DELAY OF THE MOTOR n.1

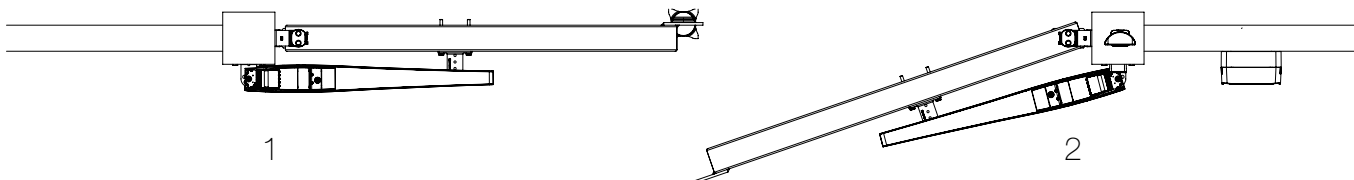

Configuration:

OPEN with OP1
COMMON with CM1
CLOSED with CL1

OPEN with OP2
COMMON with CM2
CLOSED with CL2

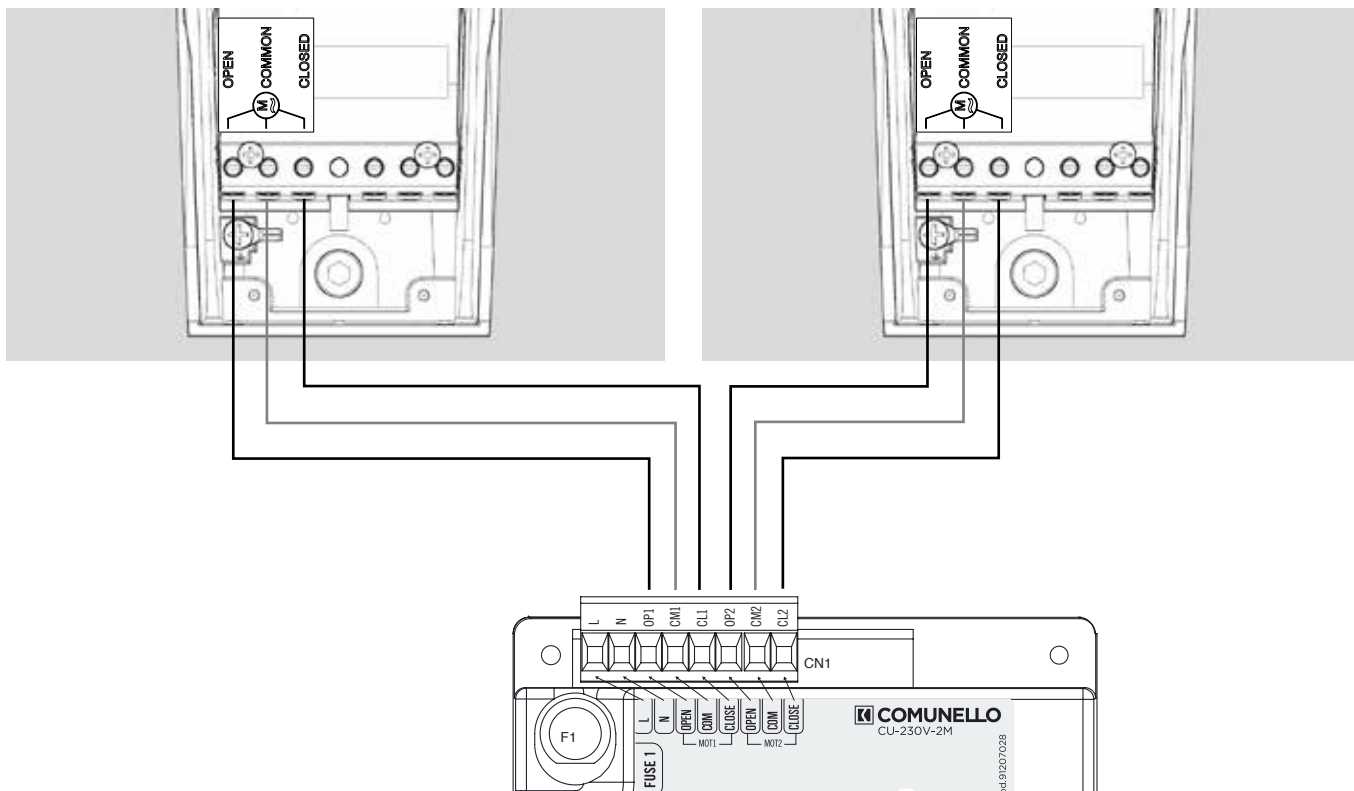

RAM - connection diagram of the motors

- DELAY LED OFF = DELAY OF THE MOTOR n.2

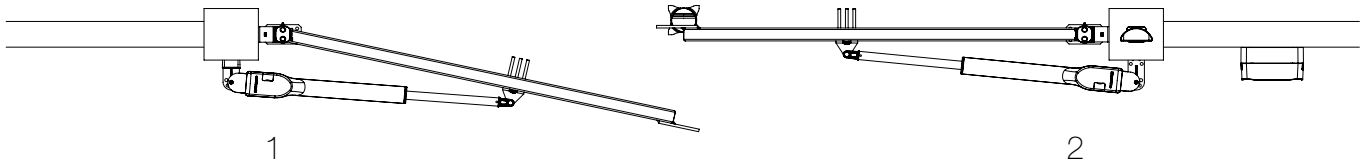

- DELAY LED ON = DELAY OF THE MOTOR n.1

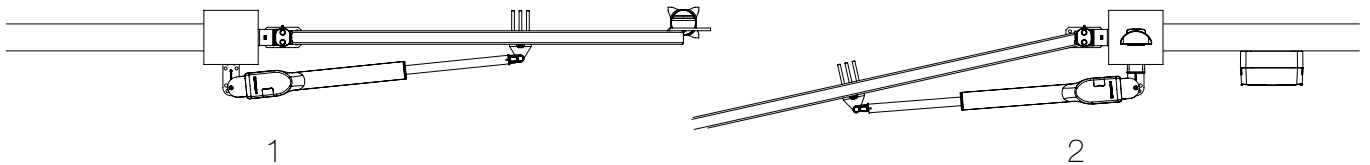

Configuration:

OPEN with OP1
COMMON with CM1
CLOSED with CL1

OPEN with OP2
COMMON with CM2
CLOSED with CL2

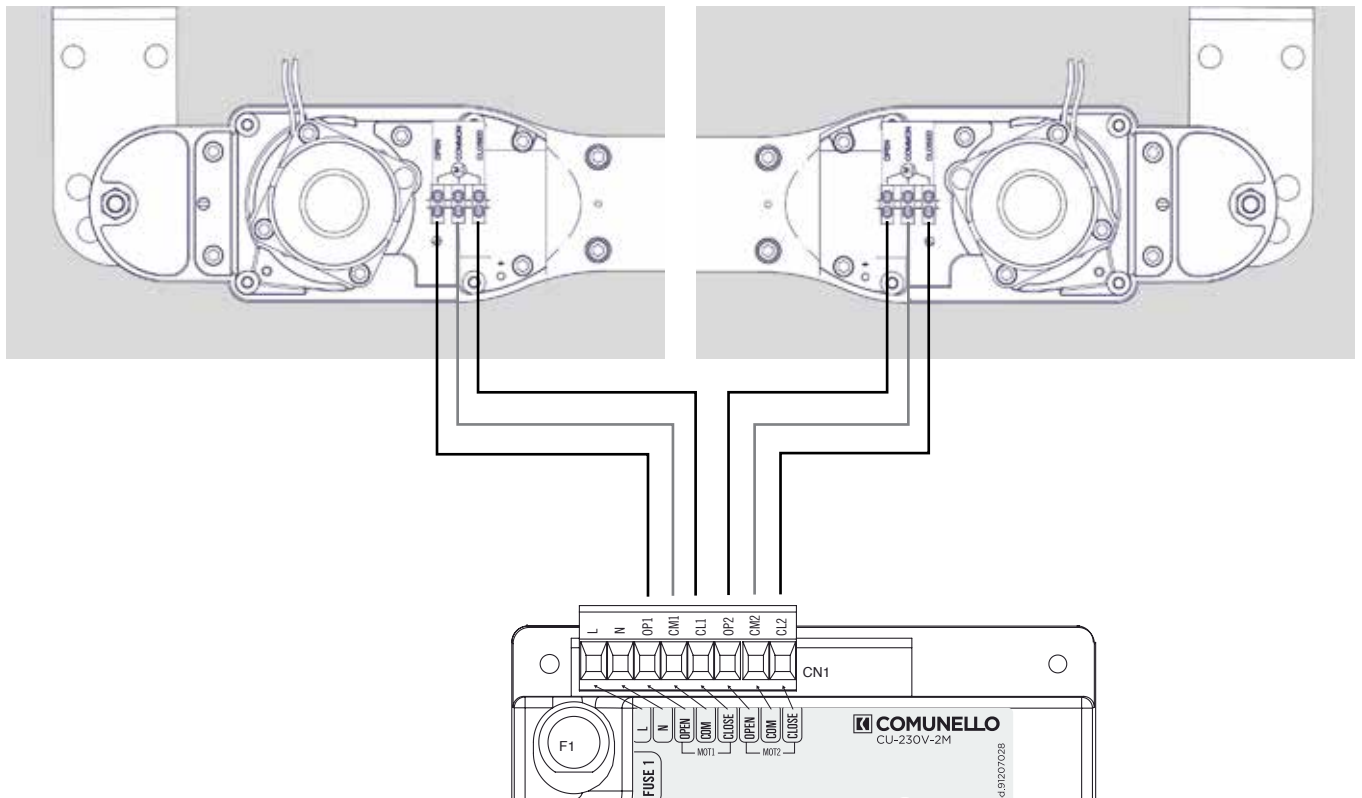

CONDOR - connection diagram of the motors [1/2]

- DELAY LED OFF = DELAY OF THE MOTOR n.2

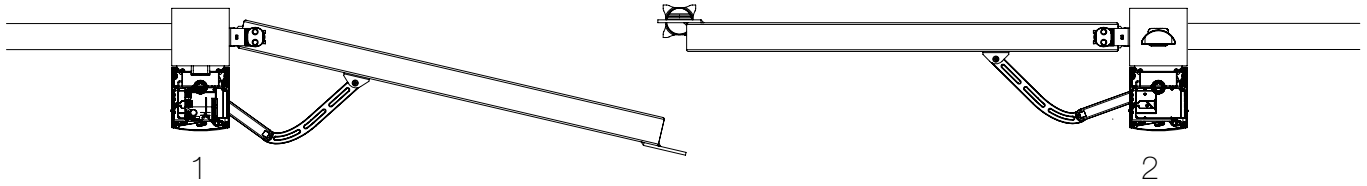

- DELAY LED ON = DELAY OF THE MOTOR n.1

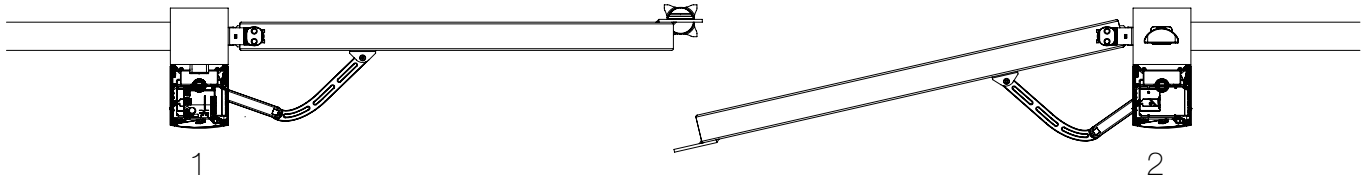

Configuration - **MASTER ON THE LEFT, SLAVE ON THE RIGHT**

MOTOR n.1 WITH CONTROL UNIT (on the left)

- BLACK with OP1
- COMMON with CM1
- BROWN with CL1

MOTOR n.2 WITHOUT CONTROL UNIT (on the right)

- OPEN with CL2
- COMMON with CM2
- CLOSED with OP2

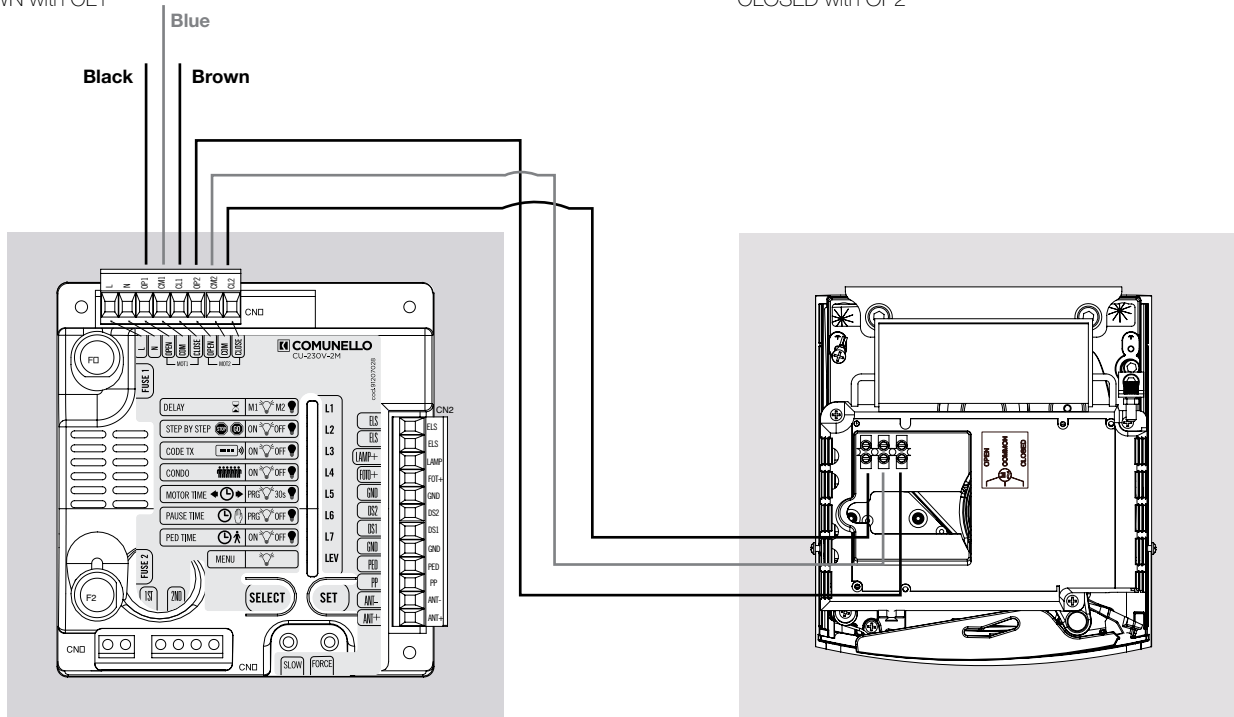

CONDOR - [2/2]

- DELAY LED OFF = DELAY OF THE MOTOR n.1

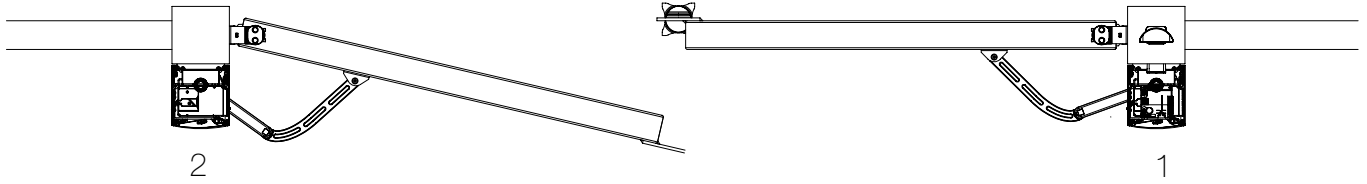

- DELAY LED ON = DELAY OF THE MOTOR n.2

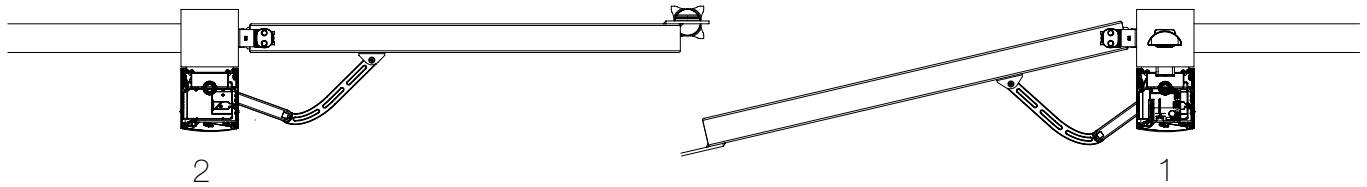

Configurazione - MASTER ON THE RIGHT, SLAVE ON THE LEFT

MOTOR n.2 WITHOUT CONTROL UNIT (on the left)

- OPEN with OP2
- COMMON on CM2
- CLOSED on CL2

MOTOR n.1 WITH CONTROL UNIT (on the right)

- [INVERT THE WIRES IN CONTROL UNIT]
- BROWN with OP1
- BLUE with CM1
- BLACK with CL1

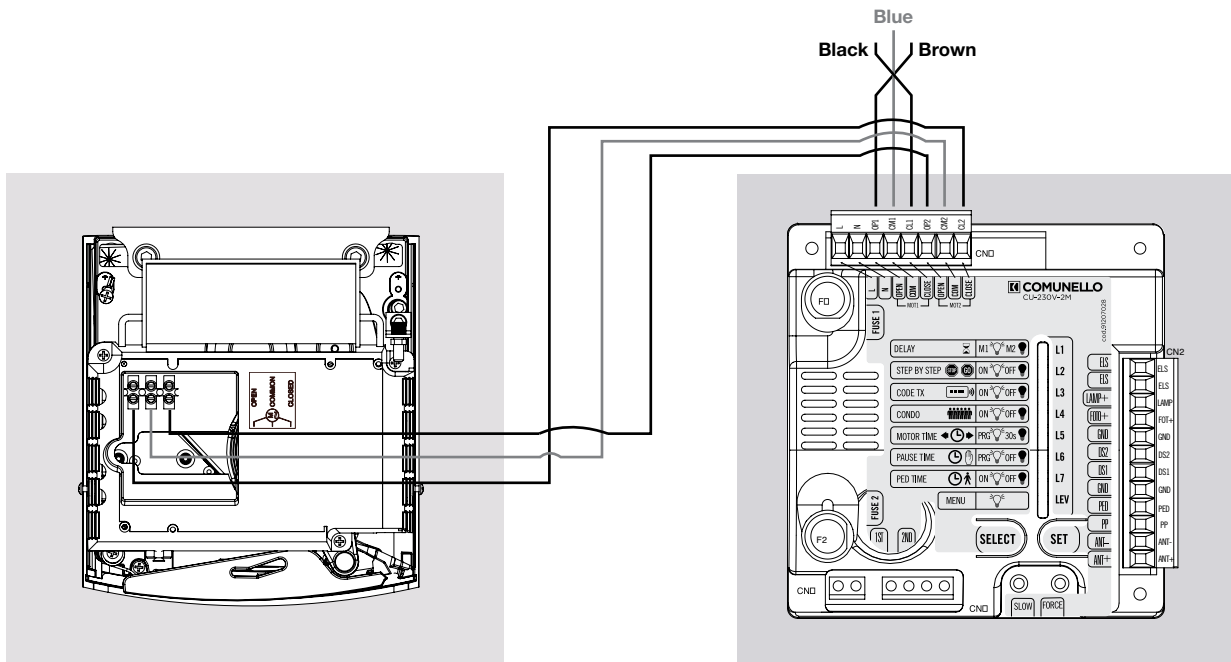

EAGLE - connection diagram of the motors

- DELAY LED OFF = DELAY OF THE MOTOR n.2

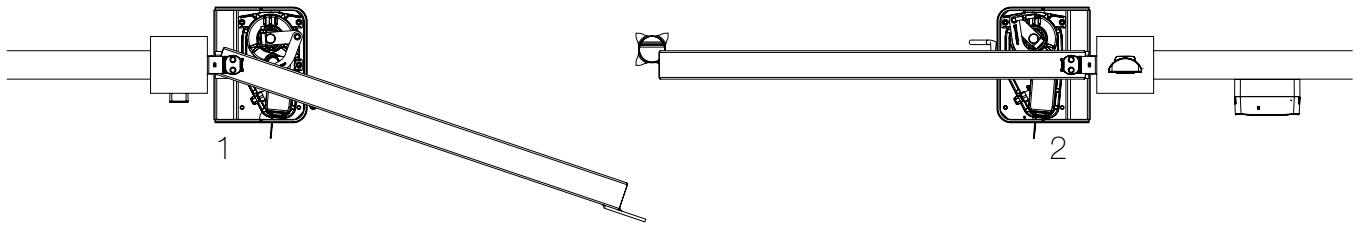

- DELAY LED ON = DELAY OF THE MOTOR n.1

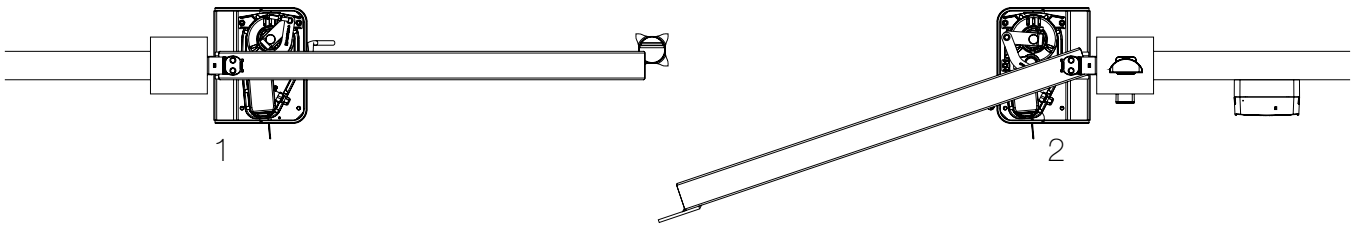

Configuration - MOTOR n.1 ON THE LEFT, MOTOR n.2 ON THE RIGHT

MOTOR n.1 (on the left)

BROWN with CL1
 BLUE with CM1
 BLACK with OP1

MOTOR n.2 (on the right)

[INVERTED CONFIG. COMPARED TO MOTOR n.1]
 BROWN with OP2
 BLUE with CM2
 BLACK with CL2

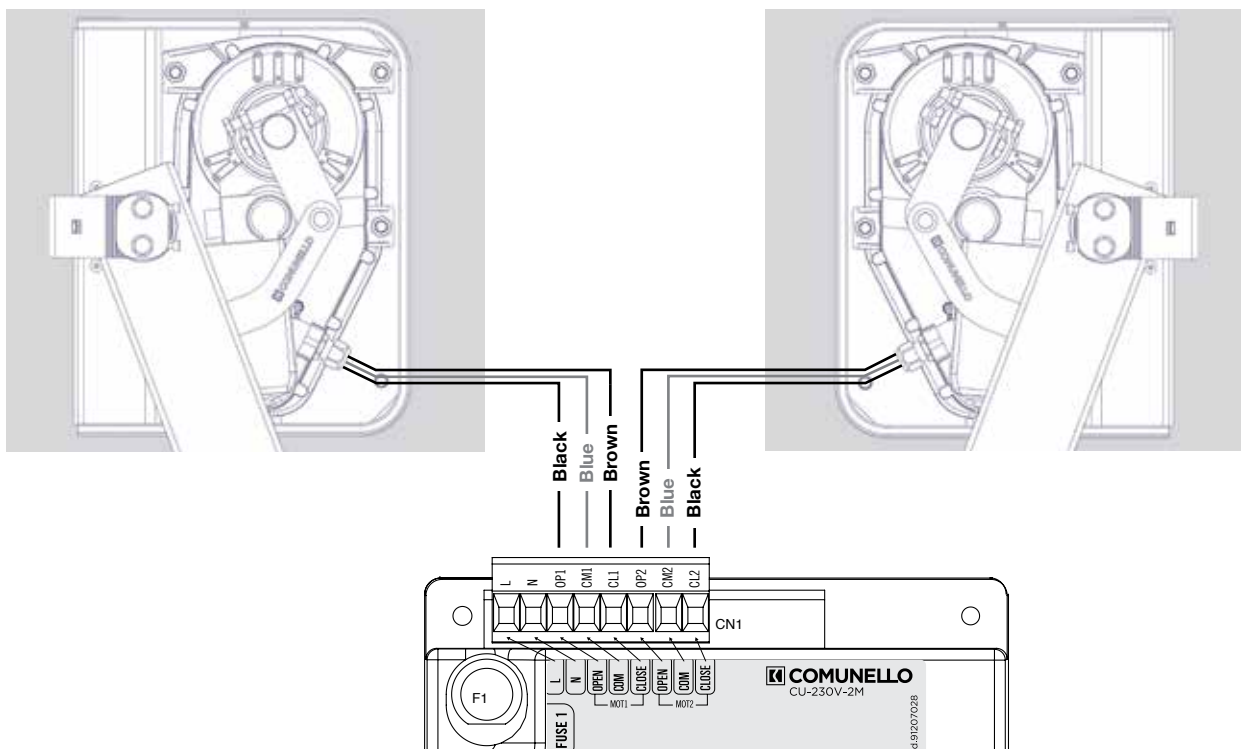

CONDOR 500 - connection diagram of the motors

- DELAY LED OFF = DELAY OF THE MOTOR n.2

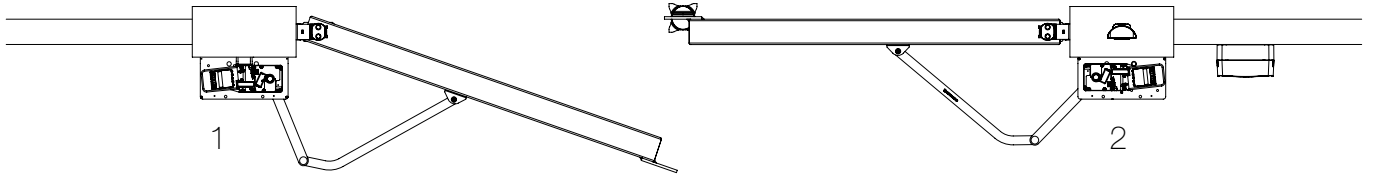

- DELAY LED ON = DELAY OF THE MOTOR n.1

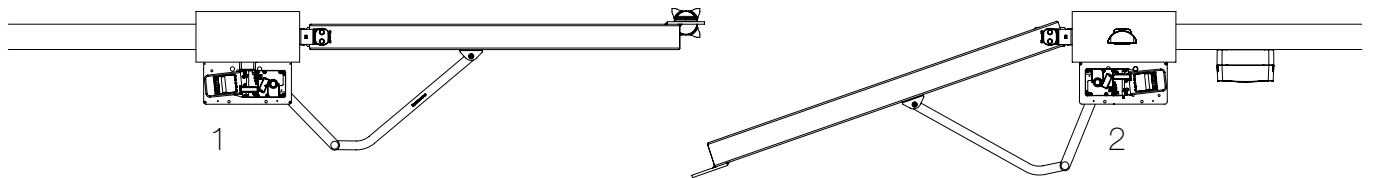

Configuration - MOTOR n.1 ON THE LEFT, MOTOR n.2 ON THE RIGHT

MOTOR n.1 (on the left)
 OPEN with OP1
 COMMON with CM1
 CLOSED with CL1

MOTOR n.2 (on the right)
 [INVERTED CONFIG. COMPARED TO MOTOR n.1]
 OPEN with CL2
 COMMON with CM2
 CLOSED with OP2

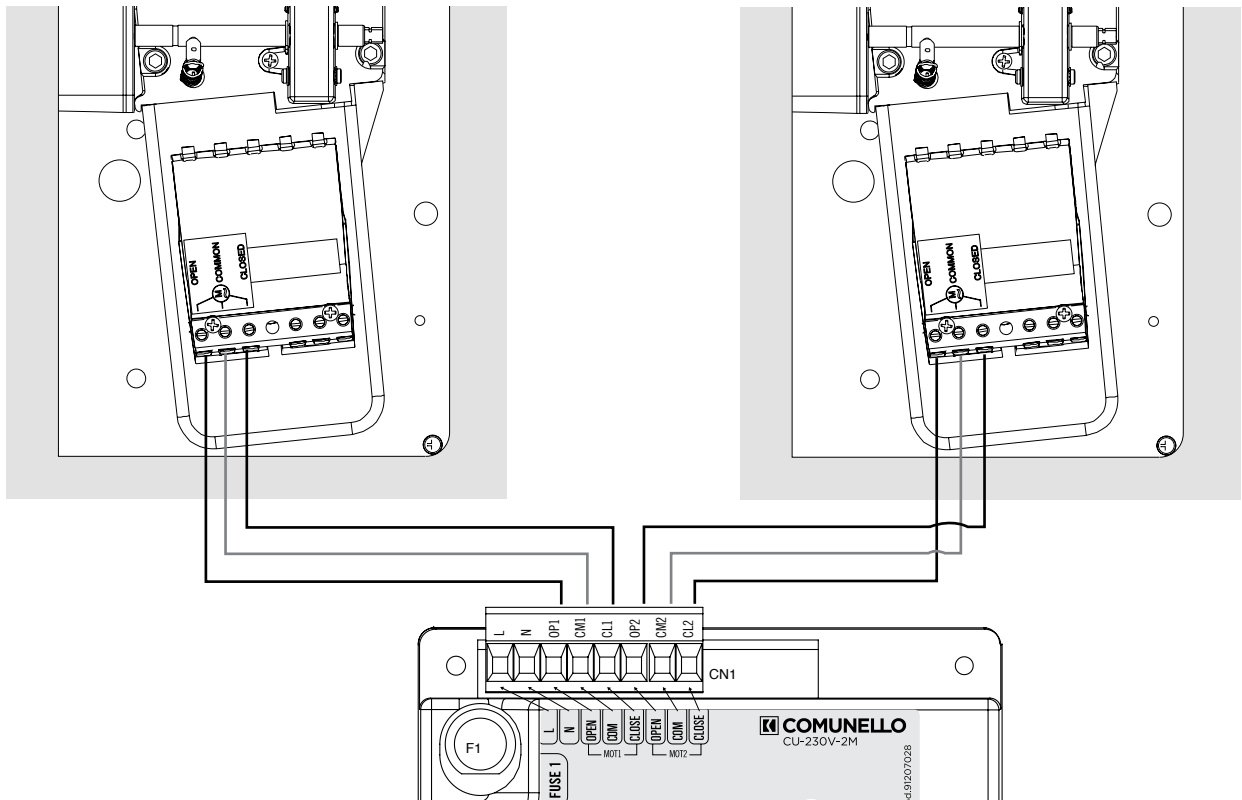

INSTALLATION AND USER'S MANUAL

CU - 230V - 2M

EC DECLARATION OF CONFORMITY:

The undersigned **Mr. Luca Comunello**, representing the following manufacturer,

Fratelli COMUNELLO Spa
Via Cassola 64, 36027 Rosà (VI) – Italy

DECLARES that the equipment described below:

Description: **Electronic control unit**
Model: **CU 230V 2M**

Is in compliance with the provisions set down in the following directives:

- 2004/108 EC Directive (EMC Directive)
- 2006/95/CE Directive

and that all the rules and/or technical specifications shown below have been applied:

EN61000-6-2 + EN61000-6-3
EN62233 :2008
EN301489-1 + EN301489-3 + EN300220-2
EN60335-1 :2002
and the following amendments.

Last two digits of the year in which the EC marking has been affixed **14**

Rosà (VI) – Italia
01-09-2014

and he also declares that it is not allowed to commission the device until the machinery where it will be incorporated or whose it will become a component will have been identified and will have been declared in compliance with the conditions of the 2006/42 EC Directive and with the national legislation that transpose it.

Mr. Luca Comunello
Fratelli Comunello Legal Representative

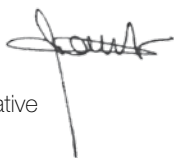

Fratelli Comunello S.p.A.
Company with certified Quality Management System
UNI EN ISO 9001:2008.

(Certificate n° 50 100 11235 Rev. 01)

PRESCRIPTIONS

The control unit is not equipped with a device for disconnection of the 230 ~ power supply line. It is therefore the responsibility of the installer to fit a disconnection device in the electrical system. The disconnection device must be of the category III overvoltage all-pole circuit breaker. This device must be positioned in such a way as to protect it against inadvertent reconnection in compliance with the requirements of EN 12453 point 5.2.9. Wiring of the external electrical devices to the control unit must be carried out in compliance with the prescriptions of EN 60204-1 as amended by EN 12453 point 5.2.7. The maximum diameter of power feeding cables is 14 mm; fixing of power feeding and connection cables must be assured by fitting cable glands, which can be supplied as optionals.

- The power input cables must be of the standardized flexible type with polychloroprene sheath (H05RN-F) having minimum conductor size of 1 mm².
- During the installation operations, take care to use cable with double insulation only (sheathed cables) for both of mains voltage connections (230V) and extra-low voltage connections (SELV). Use exclusively plastic cable trays, separated for mains voltage wiring (230V) and extra-low voltage wiring (SELV).
- The extra low voltage conductors must be physically separated (at least 4 mm in air) from the mains voltage wires, or shall be adequately insulated with extra insulation with a thickness of at least 1 mm.
- Upstream of main supply, install a device that ensures the complete omnipolar disconnection (cut-off switch) of the power supply, with a contact opening gap of at least 3mm in each pole. These disconnecting devices shall be placed in the power supply wiring in compliance with the installation standards and must be directly connected to the supply terminals.
- When drilling the outer case to insert the power and connection cables and when fitting the cable glands, take care to install all the parts in a manner that maintains the IP protection characteristics of the box unchanged as far as possible. Ensure the cables are fixed in a stable and secure manner.
- The rear of the box is equipped with knockouts for wall fixing (knockouts for fixing holes using anchor bolts or holes for fixing with screws). Take all the measures required to ensure the installation procedures do not affect the IP rating.

- If required, a pushbutton panel for manual control of the gate must be installed in a position such as to ensure the user is not placed in danger.
- The operator utilized to move the gate must be in compliance with the prescriptions of EN 12453, point 5.2.7.
- Foto+ output must be used for photocells. Alternative uses of this output are not permitted.
- At each operating cycle, the control unit can test the photocells operation to ensure protection against failure of anti-crushing protective devices according to Category 2 in compliance with the prescriptions of EN 12453 point 5.1.1.6. It follows that if the safety devices are not connected or are faulty, operation of the control unit will be inhibited.
- The device can be used by children no older than 8 years old and people with reduced physical, sensory or mental capabilities, or lack of experience or without the required knowledge, but only under surveillance or after having received instructions about the safe use of the device and the hazards inherent in it. Children should not play with the device. Cleaning and maintenance should not be carried out by children without supervision.

For correct operation of the radio receiver section, when using two or more control units it is good practice to install them at a minimum distance of 3 metres from one another.

All operations that require the control unit box to be opened (connection of cables, programming, etc.) must be carried out by expert personnel at the time of installation.

IMPORTANT INFORMATION FOR USERS

- The device must not be used by minors or psychologically-physically differently-abled persons unless they are supervised or duly instructed on the operation and methods of use.
- Do not let children play with the device and keep the remotes out of their reach.
- **IMPORTANT:** keep this instruction manual and comply with the safety prescriptions set down herein. Failure to comply with the prescriptions may cause damage and serious accidents.

Frequently examine the system to identify any signs of damage. Do not use the device if the enclosure is in need of repair (re-programming, repair or modification of the installation); contact technical service.

TECHNICAL SPECIFICATIONS

Power supply:	230 V~ 50Hz 1600W max.
Flashing light output:	24 V~ 4W max.
Operator outputs:	230 V~ 2 x 500 W max.
Electric lock output:	Voltage-free contact (24V 5A max.)
Photocells power supply:	24 V~ 5 W max.
LV safeties and controls:	24 Vcc
Working temperature:	-20 ÷ 55 °C
Radio receiver:	433 Mhz
Transmitters:	18 Bit o Rolling Code
Max TX codes stored in memory:	120 (CODE o CODE PED)
Board dimensions:	100x105 mm

PRELIMINARY CHECKS

- Check that the product in the pack is intact and in good condition.
- Check that the place of installation is suitable and in compliance with the minimum dimensions shown in FIG. 1.

INSTALLATION

- Drill the box in the four corners and then fix the photocells to the wall (FIG. 2).
- Drill a hole in the underside of the box for the cable inlet. (FIG. 3). The use of cable glands is recommended.

CONNECTIONS

CN1:

L:	230 V~ line input (phase).
N:	230 V~ line input (neutral).
OPEN1:	Operator 1 opening output.
COM1:	Operator 1 output common.
CLOSE1:	Operator 1 closing output.
OPEN2:	Operator 2 opening output.
COM2:	Operator 2 output common.
CLOSE2:	Operator 2 closing output.

CN2:

ELS:	Voltage-free contact Electric Lock output.
ELS:	Voltage-free contact Electric Lock output.
LAMP+:	Flashing light output (24 V~ 4W max).
FOTO+:	Photocells Control and Power Supply (24V~ 5W max).
GND:	Common power supply (GND).
SAFE2:	Safety Device 2 Input (NC).
SAFE1:	Safety Device 1 Input (NC).
GND:	Common GND input.
PED:	Pedestrian Pushbutton Input (NO).
PP:	Open/Close command Pushbutton input (NO).
ANT:	Antenna Ground Input.
ANT+:	Antenna Hot pole input.

TRANSFORMER CONNECTIONS

CN3 1st:

- 1: 230 V~ Transformer Primary Winding Input.
- 2: 230 V~ Transformer Primary Winding Input.

CN4 2nd:

- 1: Transformer SEC 1 Output 12.5V 0.17A no-load voltages.
- 2: Transformer SEC 1 Output 12.5V 0.17A no-load voltages.
- 3: Transformer SEC 2 Output 24.5V 0.4A no-load voltages.
- 4: Transformer SEC 2 Output 24.5V 0.4A no-load voltages.

FUNCTIONAL CHARACTERISTICS

AUTOMATIC OPERATION:

When either the remote or the low voltage pushbutton panel is used to control the gate, operation is as follows:

the first command opens the gate until motor time elapses or until the gate reaches its opening limit position; the second command closes the gate; if another command is transmitted before motor time has elapsed or before one of the two limit stops has been reached, the control unit reverses the movement direction during both opening and closing.

STEP-BY-STEP OPERATION:

When either the remote or the low voltage control pushbuttons are used to control the gate, operation is as follows:

the first command opens the gate until motor time or until the gate reaches its opening limit position; the second command closes the gate;

if another command is transmitted before motor time has elapsed or before one of the limit stops has been reached, the control unit stops the movement. Another command causes the gate to start moving again in the opposite direction.

Step-by-step 1 operations:

When either the remote or the low voltage control pushbuttons are used to control the gate, operation is as follows:

the first command opens the gate until motor time or until the gate reaches its opening limit position; the second command closes the gate; if another command is transmitted before motor time has elapsed or before one of the limit stops has been reached, the control unit stops the movement during both opening and closing. Another command causes the gate to start moving again in the opposite direction.

AUTOMATIC CLOSING:

The control unit can be set up to close the gate automatically without sending any additional commands. The selection of this type of operation is described in Pause time programming mode.

PHOTOCELLS:

Photocells can be powered by and connected to the control unit in accordance with directive EN 12453.

DS1 input (NC)

Tripping of the photocells during opening is disregarded, while during closing it causes reversal of the direction of movement.

DS2 input (NC)

Tripping during opening causes momentary stopping of the gate; once the safety is freed the control unit resumes the opening movement. Tripping during closing causes reversal of the direction of movement. To allow operation in compliance with EN 13849-1 Category 2 a photocell test is performed before each movement. The control unit enables the movement only if the test is passed; if it is not, the control unit inhibits all movements and an alarm condition is signalled by blinking of all the programming LEDs on transmission of each command.

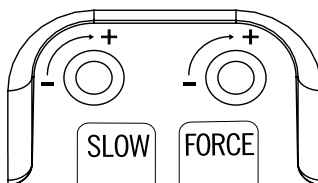

OPERATOR FORCE ADJUSTMENT (FORCE):

The electronic control unit is equipped with a "FORCE" trimmer for adjustment of the force delivered by the operators, completely managed by the microprocessor. Adjustment can be performed in a range of between 50% and 100% of maximum force. Initial starting torque can be set for each movement by feeding the operators at full power for 2 seconds, even if operator force control is enabled. Note: initial starting torque is disabled automatically if the Soft Start function is enabled.

IMPORTANT: If the "FORCE" trimmer is adjusted the learning procedure must be repeated because the movement and deceleration times may change.

DECELERATION (SLOW):

The operators deceleration function is used on gates to prevent the moving leaves from slamming at speed into the limit stops at the end of the opening and closing strokes. During Motor Time programming (see Main menu) the control unit also allows programming of deceleration in the desired positions (before total opening and closing). If the "Automatic Programming" function is used (see extended menu 1) it is still possible to include a deceleration stage only for the first 4 seconds of the movement.

OPERATION WITH TIMER:

The control unit allows a timer to be connected in place of the open – close pushbutton. E.g.: at 08.00 am the timer closes the contact and the control unit commands an opening movement; at 06.00 pm the timer opens the contact and the control unit commands a closing movement. From 08.00 am – 06.00 pm at the end of the opening cycle the control unit disables the flashing light, automatic closing and the remotes.

ELECTRIC LOCK CONTROL OUTPUT:

The control unit features a voltage-free output contact to power an electric lock. The contact is closed at each initial opening movement for a period of 2 seconds.

PROGRAMMING:



SELECT key: selects the type of function to store; the selection is indicated by blinking of the LED.

Press the key twice to go to the desired function. The selection remains active for 10 seconds shown by blinking of the LED; when this interval elapses the control unit returns to the original state.

SET key: programs the information in accordance with the function type preselected with the SELECT key.

IMPORTANT: the SET key function can be replaced by the remote if programmed beforehand.

Programming enabled only when safety devices are not active.

		ON 	OFF 
L1	DELAY	Operator 1 delay	Operator 2 delay
L2	STEP-BY-STEP	Step-by-Step	Automatic
L3	TX CODE	Code entered	No code
L4	CONDO	ON	OFF
L5	MOTOR TIME	Programmed time	30 sec.
L6	PAUSE TIME	With automatic closing	Without automatic closing
L7	PED. TIME	ON	OFF
LEV	MENU	ON	

MAIN MENU

The control unit is factory set to allow the selection of several important functions.

1. DELAY:

In the default configuration the control unit is set up with "OPERATOR 2 DELAY" logic. To avoid having to disconnect the wiring in order to set a delay for operator 1 rather than operator 2, proceed as follows: use the SELECT key to select blinking LED L1 and then press the SET key: LED L1 becomes steady on and programming will be completed. Repeat the procedure if you want to restore the previous configuration.

2. STEP BY STEP:

In the default configuration the control unit is set with "Automatic" operating logic enabled (LED n2 off); if the "Step-by-Step" operating logic is required (LED n2 on), proceed as follows: use the SELECT key to select blinking LED n2 and then press the SET key: LED n2 becomes steady on and programming will be completed.

If the "Step-by-Step 1" operating logic is required, repeat the operation above described, by pressing the SEL key twice instead only one (to obtain the quick blinking of LED. Repeat the procedure if you wish to restore the previous configuration.

3. TX CODE (Remote control code):

Up to 120 remotes with different codes, either of the fixed or the rolling code type can be saved on the control unit.

Programming:

Programming of the transmission code is performed as follows: use the SELECT key to select blinking LED L3. Press SET once; the LED will change its blinking mode (longer 1 0 1 0) to show that the first level is being saved. On sending the selected code with the desired remote, the LED will remain steady on to indicate that programming has been completed. To save the code for pedestrian opening / single leaf proceed as follows: use the SELECT key to select blinking LED L3. Press SET twice consecutively; the LED will change its blinking mode (1 1 0 1 1 0) to show that the pedestrian code is being saved. On sending the selected code with the desired remote LED L3 will remain steady on to indicate that programming has been completed. If all 120 codes have been saved, repeating the programming operation will cause all the programming LEDs to start blinking, to signal that no further codes can be saved.

Deletion:

Use SELECT to go to LED L3; activate blinking of the code to be deleted (CODE or PEDESTRIAN identified by the respective blinking); press and hold down SET for > 5 s. After this interval the LED will switch off for 2 seconds and the procedure is completed. If all CODE and PEDESTRIAN codes are deleted, the LED will remain off. If only PEDESTRIAN codes remain stored, the LED blinking mode will change (1 1 1 1 0 1 1 1 0).

Rule of the first saved Remote control:

When programming remotes the following rule is applied: if the first remote to be saved is of the rolling code type, the receiver will subsequently accept only rolling code remotes, thus providing enhanced anti-intrusion security; if the first remote to be saved is a fixed code type, the receiver will

subsequently accept both fixed code remotes and rolling code remotes, although only the fixed part of the latter will be controlled (thus effectively relinquishing the security of the rolling code system).

4. CONDO:

The Condominium function means that during the opening movement or during the pause time the control unit will not respond to commands sent by Pushbuttons or remotes. In contrast, during the closing movement a command sent by the Pushbuttons or the remotes will reverse the direction of movement. This operating mode is invaluable when the automation includes a loop detector. In the default configuration the control unit is set with the Condominium function disabled; if the Condominium function is required, proceed as follows: use the SELECT key to select blinking LED L4 and then press the SET key: LED L4 becomes steady on and programming will be completed. Repeat the procedure if you want to restore the previous configuration.

5. MOTOR TIME:

(Programming motor time of the operators with max 4 minutes). The control unit is factory set with a preset motor time of 30 seconds without deceleration. If the motor time of the operators must be changed, programming must be carried out with the gate closed as follows: use the SELECT key to select blinking LED L5 and then press the SET key momentarily; the operator will start the opening movement; when the desired deceleration starting point is reached press the SET key again; at the same time the operator will decelerate and reach the desired position; press SET to terminate the opening cycle. Thereafter LED L5 will start blinking rapidly; now repeat the motor time and deceleration programming procedure for the closing cycle. If you do not require the control unit to perform the deceleration, during programming, when the open-close cycle has been completed press the SET key twice consecutively rather than just once. During programming, instead of the SET key on the control unit you can use the button on the remote, providing the remote has been saved beforehand.

6. PAUSE TIME:



(Automatic closing time programming 4 min. max.) The control unit is factory set with automatic closing disabled. If you wish to enable automatic closing proceed as follows: use the SELECT key to select blinking LED L6 and press the SET key momentarily; now wait for a time equivalent to the time interval desired; press the SET key again momentarily and at the same time the automatic closing time will be saved and LED L6 will remain steady on. If you wish to restore the initial condition (no automatic closing) select blinking LED L6 and then press the SET key twice consecutively in a time period of 2 seconds. The LED will switch off and the operation will be completed. During programming, instead of the SET key on the control unit you can use the button on the remote, providing the remote has been saved beforehand.

7. PED TIME (Programming of pedestrian motor time, 4 minutes max):

The control unit is factory set with a preset Operator run time (Pedestrian) of 10 seconds without deceleration. If the pedestrian run time must be changed, programming must be carried out with the gate closed as follows: use the SELECT key to select blinking LED L7 and then press the SET key momentarily; the Operator will start the opening movement; when the desired deceleration starting point is reached press the SET key again; LED L7 will start blinking more slowly and the Operator will decelerate; on reaching the desired position press SET to terminate the Opening cycle. At this point LED L7 returns to the normal blinking speed and the Operator restarts in the Closing movement; repeat the operations described above for the Closing movement. If you do not require the control unit to perform the deceleration, during programming, when the open-close cycle has been completed press the SET key twice consecutively rather than just once. During programming, instead of the SET key on the control unit you can use the button on the remote, providing the remote has been saved beforehand.

EXTENDED MENU 1

The control unit is factory set to allow direct selection exclusively of the main menu functions. If you want to enable the functions described in Extended Menu 1, proceed as follows: select blinking LEV LED and press SET once. The LED will start blinking. This means there will be 30 seconds to select the functions of Extended Menu 1 using the SELECT and SET keys; once an additional 30 seconds have elapsed the control unit reverts to the main menu.

		ON 	OFF 
L1	PGM CODE	ON	OFF
L2	FOTOTEST	ON	OFF
L3	DECELERATION	OFF	ON
L4	LEAVES DELAY	ON	OFF
L5	RELEASE STROKE	ON	OFF
L6	SLAM LOCK	ON	OFF
L7	COURTESY LIGHT	ON	OFF
LEV	MENU	1 FLASH	

1. REMOTE CODE PGM (Remote Programming of Radio Controls):

The control unit allows the transmission code to be programmed from a distance without acting directly on the control unit SELECT key. Remote programming of the Radio Remote Controls is performed as follows: send, continuously for a time in excess of 10 seconds, the code of a previously saved remote; at the same time the control unit switches to programming mode as described above for LED L3 in the main menu. If a pedestrian code previously stored in the control unit is transmitted continuously, the control unit switches to programming of a new pedestrian code. The control unit is factory set with transmission code programming from a distance disabled, proceed as follows if you want to enable the function: make sure you have enabled Extended Menu 1 (shown by 1 0 1 0 1 blinking of the LEV LED), press the SELECT key to select blinking LED L1 then press the SET key, at the same time LED L1 becomes steady on and programming will be completed. Repeat the procedure if you want to restore the previous configuration.

2. FOTOTEST (Photocells test):

The control unit is factory set with the photocells test disabled. To enable the test, proceed as follows: make sure you have enabled Extended Menu 1, use the SELECT key to select blinking LED L2 then press the SET key, LED L2 becomes steady on and the programming procedure will be completed. Repeat the procedure if you want to restore the previous configuration.

3. DECELERATION:

As mentioned earlier, the control unit allows programming of a deceleration stage during opening and closing. However, if no deceleration is required, this stage can be inhibited. If, before excluding the deceleration stage it had already been programmed using the Motor Times Programming function, programming must be repeated from the beginning. If the deceleration stage is to be excluded proceed as follows: make sure you have enabled Extended Menu 1, use the SELECT key to select blinking LED L3 and then press the SET key: LED L3 becomes steady on and programming will be completed. Repeat the procedure if you want to restore the previous configuration.

4. LEAVES DELAY:

(15 sec. max leaf delay programming). The control unit is factory set with leaves opening and closing delay disabled (4 sec.). If the control unit is used in the configuration for an automation with 2 operators, it may be necessary to set a different leaves delay time; programming must be performed with the gate closed as follows: make sure you have enabled Extended Menu 1, press the SELECT key to select blinking LED L4 then press the SET key momentarily; now wait for a time equivalent to the desired time interval and then press the SET key again momentarily, at the same time the fixed 4 second leaves opening delay and the closing delay for the programmed time will be saved and LED L4 will remain steady on. If you want to deactivate this function (without leaves delay), select blinking LED L4 and then press the SET key twice consecutively in a time interval of 2 seconds, at the same time the LED will switch off and the operation will be terminated.

5. RELEASE STROKE:

The control unit is factory set with the release stroke function disabled. To enable the Release Stroke function at maximum power, proceed as follows: make sure you have enabled Extended Menu 1, use the SELECT key to select blinking LED L5 then press the SET key, LED L5 becomes steady on and the programming procedure will be completed. If you wish to enable the Release Stroke function at the power set with the "FORCE" trimmer, repeat the procedure described above, press the SELECT key twice (LED L5 will blink rapidly) rather than just once. Repeat the procedure if you want to restore the initial configuration. This procedure makes it possible to facilitate release of the gate lock and thus allow correct execution of the opening stroke. With this function, before starting the opening stroke the control unit sends a closing command for 2 seconds with the thrust force associated with the selection made.

6. SLAM LOCK:

The control unit is factory set with the Slam Lock function disabled. This function consists in adding, in the presence of a deceleration stage during closing, 1 extra second at the maximum power or at the power selected with the "FORCE" trimmer, in such a way as to ensure positive engagement of the gate lock, if installed. If you want to enable the Slam Lock function at maximum power, proceed as follows: make sure you have enabled Extended Menu 1, use the SELECT key to select blinking LED L6 and then press the SET key: LED L6 becomes steady on and programming will be completed. If you want to enable the Slam Lock function at the power set with the "FORCE" Trimmer, repeat the operation described by pressing the SELECT key twice (LED L6 will blink rapidly) rather than once. Repeat the procedure if you want to restore the initial configuration.

7. PREFLASHING/COURTESY LIGHT:



The control unit is factory set with the Preflashing and Courtesy Light functions disabled. If you want to enable the Preflashing function proceed as follows: make sure you have enabled Extended Menu 1, use the SEL key to select blinking LED L7 and then press the SET key: the LED becomes steady on and programming will be completed. If you want to enable the Courtesy Light function, repeat the operation described above, pressing the SELECT key twice (the LED will blink rapidly) rather than once. Repeat the procedure if you want to restore the initial configuration.

Preflashing Operation: the 24 ~ 4W max. Flashing Light output will always switch on 3 seconds before the gate starts the closing operation.

Courtesy Light Operation: the 24 ~ 4W max. Courtesy Light output will switch on for 3 minutes whenever an opening command is transmitted.

EXTENDED MENU 2

The control unit is factory set to allow direct selection exclusively of the main menu functions. If you want to enable the functions described in Extended Menu 2, proceed as follows: select blinking LED LEV and press SET twice. The LED will start blinking alternately 1 1 0 1 1 0 1 1 0. This means there is a period of 30 seconds to select the functions in Extended Menu 2 using the SELECT and SET keys and then, after a further 30 seconds, the control unit will revert to the main menu.

		ON 	OFF 
L1	SOFT STOP	ON	OFF
L2	SOFT START	ON	OFF
L3	DS1 IN OPEN	ON	OFF
L4	HOLD-TO-RUN	ON	OFF
L5	FOLLOW ME	ON	OFF
L6	PAUSE FLASHING	ON	OFF
L7	ALWAYS CLOSE	ON	OFF
LEV	MENU	2 FLASHES	

1. SOFT STOP:

The control unit is factory set with the Soft Stop function disabled. If you wish to enable the function, proceed as follows: ensure you have enabled Extended Menu 2 and then use the SEL key to select blinking LED L1 and press the SET key; at the same time LED L1 becomes steady on and programming will be completed. With this function enabled at the end of the movement the control unit will reduce operator force to zero gradually in a 2 second interval. Repeat the procedure if you want to restore the previous configuration.

2. SOFT START:

The control unit is factory set with the Soft Start function disabled. If you wish to enable the function, proceed as follows: ensure you have enabled Extended Menu 2 and then use the SEL key to select blinking LED L2 and press the SET key; at the same time LED L2 becomes steady on and programming will be completed. With this function enabled at the start of each movement the control unit will modulate start-up of the operator, gradually increasing the force from the minimum to the value set by the "FORCE" trimmer during the first 2 seconds of operation. Repeat the procedure if you wish to restore the previous configuration.

Note: when the Soft Start function is enabled, the control unit automatically disables the Starting Torque function, while if Soft Start is disabled, then Starting Torque is automatically enabled.

3. DS1 ALSO IN OPENING:

The control unit allows the operation of input DS1 to be modified. If you want DS1 to operate also during opening (momentary stopping of the gate, as soon as it is freed the control unit resumes the opening movement),

proceed as follows: ensure you have enabled Extended Menu 2 and then press the SEL key to select blinking LED L3 and press the SET key: LED L3 becomes steady on and programming will be completed. Repeat the procedure if you want to restore the initial configuration.

4. HOLD-TO-RUN:

The control unit provides the opportunity to set the "Hold-to-Run" function. If you wish to enable the function, proceed as follows: ensure you have enabled Extended Menu 2 and then use the SEL key to select blinking LED L4 and press the SET key; at the same time LED L4 becomes steady on and the operation will be completed.

With this function enabled using either the remotes or the Pushbuttons to operate the gate, the following operation will be obtained: the command must be maintained constantly to move the gate. When the command is released movement will stop immediately. Repeat the procedure if you want to restore the previous configuration.

5. FOLLOW ME

The control unit allows the "Follow me" function to be configured; programmable only if a Pause Time has already been set, this function reduces the Pause Time to 5 seconds after freeing the SAFE1 photocells, meaning the gate re-closes 5 seconds after transit of the user. To activate this function proceed as follows: ensure you have enabled Extended Menu 2 and then press the SELECT key to select blinking LED L5 and then press the SET key: LED L5 becomes steady on and programming will be completed. Repeat the procedure if you want to restore the previous configuration.

6. FLASHING LIGHT OPERATION

The control unit is factory set with Flashing Light operation during Pause Time disabled. If you want to enable this function, proceed as follows: make sure you have enabled Extended Menu 2, press the SELECT key to select blinking LED L6 and then press the SET key: LED L6 becomes steady on programming will be completed. Repeat the procedure if you want to restore the previous configuration.

7. ALWAYS CLOSE FUNCTION

The control unit provides the facility to set "Always Close" operation: this function, which is programmable only if a Pause Time has already been programmed, is activated after a power loss; if the gate open condition is confirmed a closing movement is started automatically, preceded by 5 seconds of preflashing. If you wish to enable the function, proceed as follows: ensure you have enabled Extended Menu 2 and then use the SEL key to select blinking LED L7 and press the SET key; at the same time LED L7 becomes steady on and the operation will be completed. Repeat the procedure if you want to restore the previous configuration.

RESET

If it becomes necessary to reset the control unit to restore the factory settings, press the SELECT and SET keys together; this will cause all the RED indicator LEDs to light simultaneously followed immediately by the control unit switching off.

DIAGNOSTICS

Photocell Test:

The control unit is prearranged for connection of safety devices in compliance with standard EN 12453 point 5.1.1.6. At each operating cycle a functional test of the connected photocell is performed. In the case of an open circuit and/or malfunctioning of the photocell, the control unit does not enable movement of the gate and visually signals the test failed condition by causing all the indicator LEDs to blink simultaneously. As soon as correct operation of the photocell is restored, the control unit is ready for normal use. This operating mode guarantees failure mode monitoring in compliance with EN 954-1 Category 2.

Commands input test:

In correspondence with each low voltage command input the control unit is equipped with an indicator LED so that the status of the input can be checked at a glance.

Operating logic: LED on input closed, LED off input open.

WARRANTY

Fratelli Comunello SpA provides a warranty for 24 months for the correct

functioning of the actuators from the date of manufacture, provided that the performance specifications indicated in the product instruction manuals are respected. Free of charge repair and replacement of components that are found to be faulty according to the indisputable judgment of the company's technical staff shall be guaranteed at the sole discretion of Fratelli Comunello Spa, and so excluding any claim for damages made by others. Warranty material shall be returned to Fratelli Comunello S.p.a. headquarters carriage paid and will then be shipped to the customer carriage unpaid. The material found to be faulty and returned to Fratelli Comunello S.p.a. shall remain property of the Seller. Any cost resulting from any work needed to repair the defect or to replace the material shall be charged to the Buyer. No compensation shall be allowed for the period of device inactivity. Work under warranty does not prolong the warranty period. The defect of the product shall be reported by the Buyer within 8 (eight) days from its discovery or from the date of delivery of the goods, under penalty of invalidation of the warranty. Such claim shall be noted in writing.

Warranty does not cover:

Any product defect or damage that may have been incurred during transport; any defect or damage arising from any fault and/or from neglect, inadequacy and misuse of the electrical wiring in the Buyer's property; any defect or damage caused by any repairs carried out by non authorised personnel or by incorrect use/installation (with reference to this, system maintenance is recommended every 6 months) or if not original spare parts are used; any defect caused by chemicals or atmospheric conditions. The warranty does not cover any cost neither for consumable materials nor for alleged defects or convenient surveys.

Product Features Fratelli Comunello SpA products are subjected to continue changes and improvements; their technical features and image may therefore change without previous notice.

Competent court

Since the contract of sale is conformed by an Order Confirmation drawn up in Rosà, any such dispute shall be settled by the laws of Italy and by the court of Vicenza (VI).

COMUNELLO 
AUTOMATION

FRATELLI COMUNELLO S.P.A.
AUTOMATION GATE DIVISION

Via Cassola, 64 - C.P. 79

36027 Rosà, Vicenza, Italy

Tel. +39 0424 585111 Fax +39 0424 533417

info@comunello.it www.comunello.com